

CR1616

3V Lithium Battery
Swiss Made

Technical Data Sheet

Specifications

Chemical System	Li / MnO ₂
Nominal Voltage	3 V
Rated Capacity	50 mAh
Standard Discharge Current	0,1 mA
Max. Cont. Discharge Current	1,0 mA
Average Weight	1,1 g
Temperature Range	-30 - +70 °C
Self Discharge at 23°C	< 1% / year

Dimensions

(According to IEC 60086)

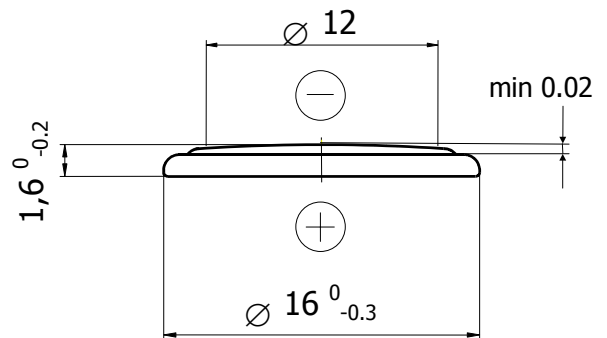

Performance

Discharge performance at 23°C

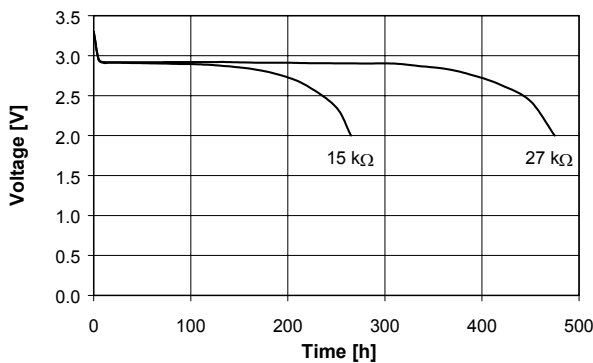

Discharge performance at 23°C

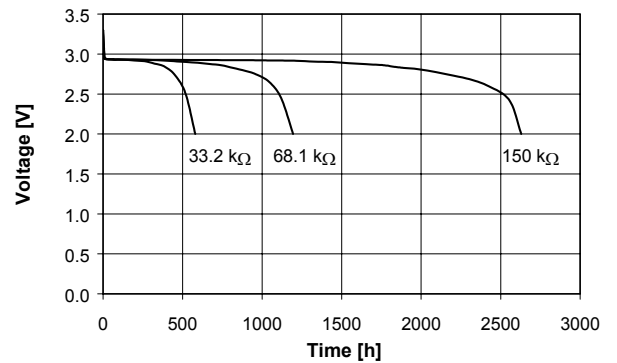

Temperature performance Load 27kΩ

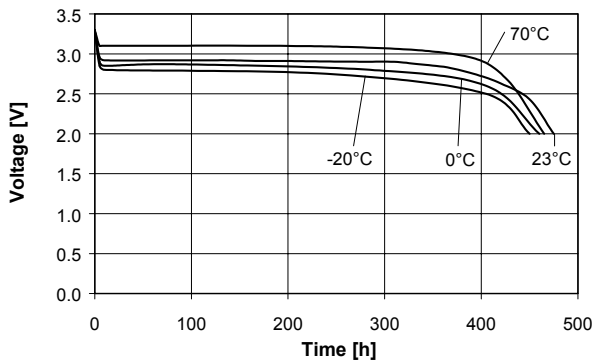

Cell capacity at various loads

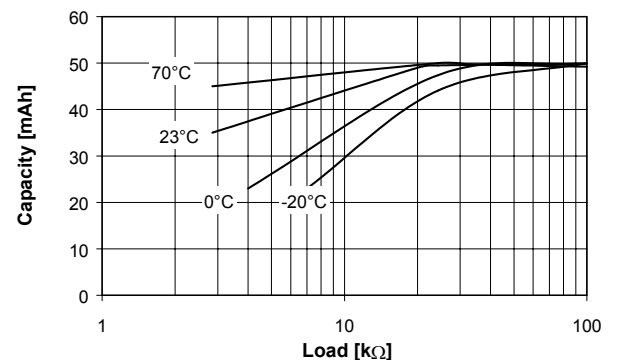

Rev. CR1616.04 10/01