

# MODEL TL-5935

International size reference: 1/6D, ER32L100

## TECHNICAL DATA

(Typical values @+25°C for batteries stored for one year or less)

- Nominal capacity @ 1 mA, to 2V 1.7 Ah
- Rated voltage 3.6 V
- Maximum recommended continuous current 10 mA
- Maximum pulse current capability 50 mA
- Weight 21 g (0.74 oz)
- Volume 8.2 cc
- Operating temperature range -55°C to +85°C
- Li metal content approx. 0.5 g

U.L. Component Recognition, MH 12193



# TADIRAN LITHIUM BATTERIES

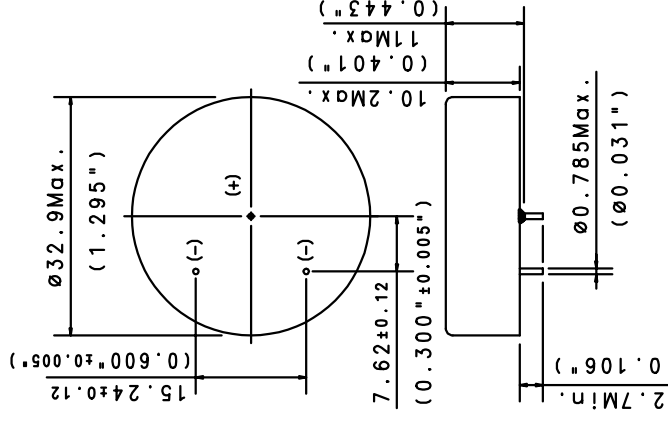

## ORDERING NO.

TERMINAL MATERIAL : TIN PLATED NICKEL  
CATALOGUE NO. : 15-5935-41500

## DISCHARGE CHARACTERISTICS @ +25°C

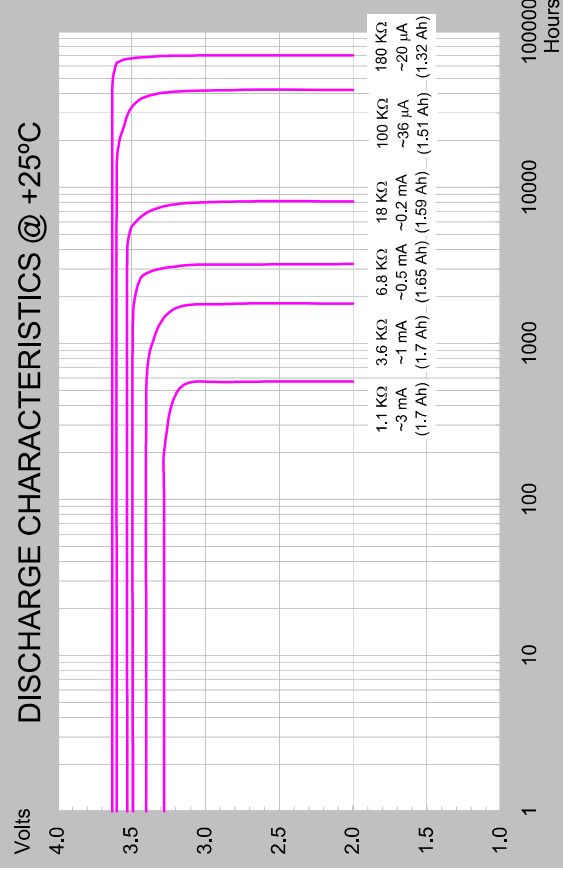

## VOLTAGE VS. TEMPERATURE

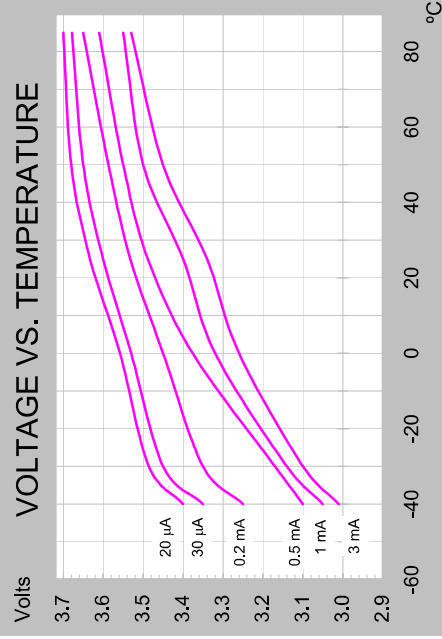

## CAPACITY VS. CURRENT

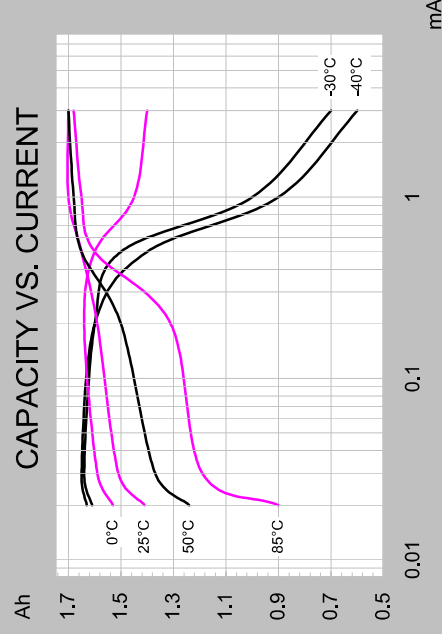

# iXtra - Long Term High Performance

Note: Any presentations in this data sheet concerning performance are for information purpose only and are not construed as warranties either expressed or implied, of future performance.

# TL-5935

## CELL FEATURES

- 3.6 V Primary lithium-thionyl chloride (Li-SOCl<sub>2</sub>)
- Fast voltage recovery after long term storage and/or usage
- High energy density
- High and stable operating voltage
- Low self discharge rate
- Wafer construction
- Hermetic glass-to-metal-sealing
- Non-flammable electrolyte

# TADIRAN LITHIUM BATTERIES

## MAIN APPLICATIONS

- Utility meters (elect., water & gas)
- Automatic meter reading
- RF systems
- Sensors & monitoring systems
- Tracking systems
- Wireless security systems
- Automotive electronics
- Industrial electronics
- Ultra Low Power (ULP)

## STORAGE CONDITIONS

- Cells should be stored in a clean & dry (less than 30 % RH) area

For updated information please visit our website [www.tadiranbat.com](http://www.tadiranbat.com)

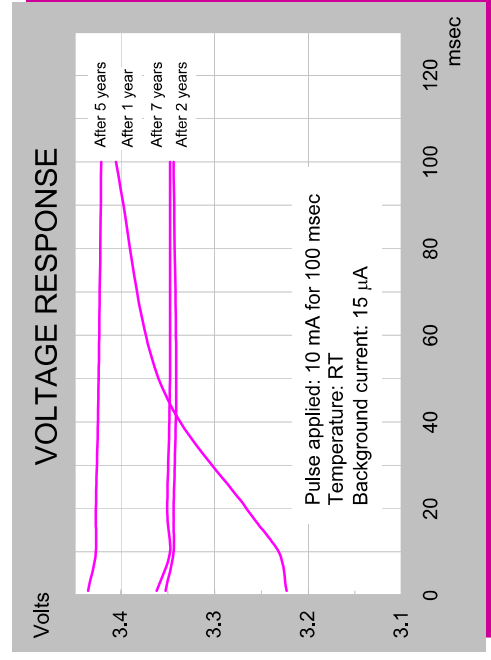
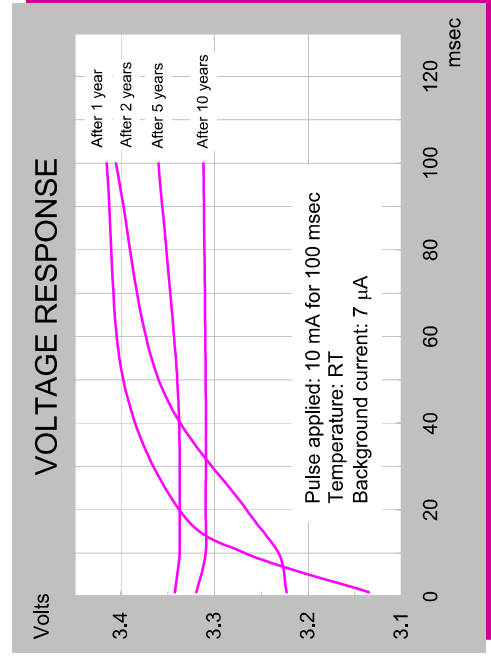
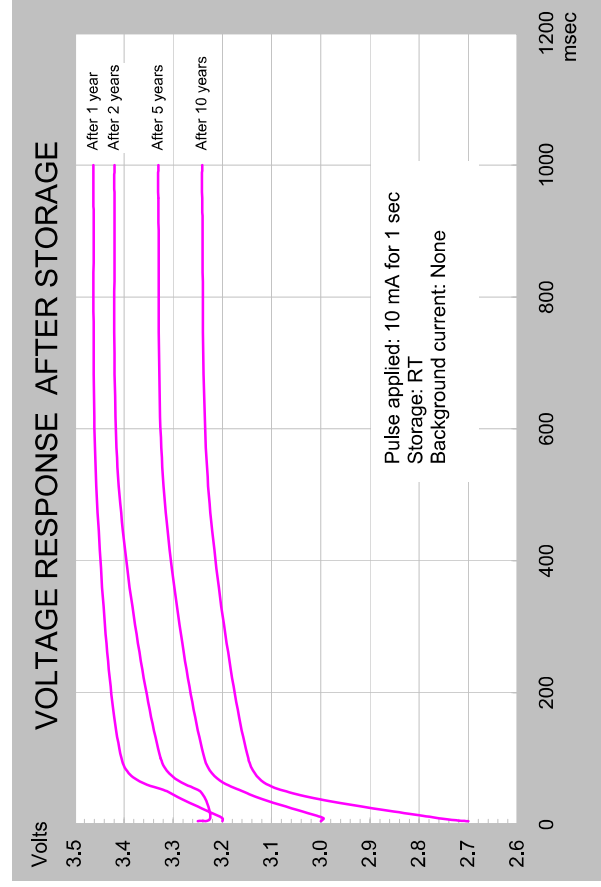

## iXtra - Long Term High Performance

Note: Any presentations in this data sheet concerning performance are for information purpose only and are not construed as warranties either expressed or implied, of future performance.

ECN 1501879 Rev. B 11/08