

**LITHIUM & MICRO BATTERIES: TYPES AND FEATURES**

Ever since Panasonic became the first company in the world to develop and commence the mass production of Lithium batteries for consumer products in 1971, Panasonic has launched a series of Lithium batteries in many shapes and sizes including cylindrical types, coin types and pin types. Panasonic has also successfully introduced coin type rechargeable Lithium batteries to the market for applications such as memory back-up or watches.

Today, Lithium batteries have a proven track record of opening up a host of new fields where conventional batteries cannot be used. Applications range from high-current discharge applications typified by 35 mm cameras to ultra-low current discharge applications in such products as electronic watches or applications as power supplies for IC memory back-up which require long-term reliability.

Panasonic has conducted repeated tests on the various safety and performance characteristics, plus the effects of environmental factors such as temperature. We have accumulated a wealth of corroborative data on the performance of our batteries which cannot be pinpointed by short-term accelerated tests. As a result, Panasonic batteries have won approval under the UL safety standards in the United States and wide recognition throughout the world for their high reliability and safety.

**TYPES OF LITHIUM & MICRO BATTERIES**

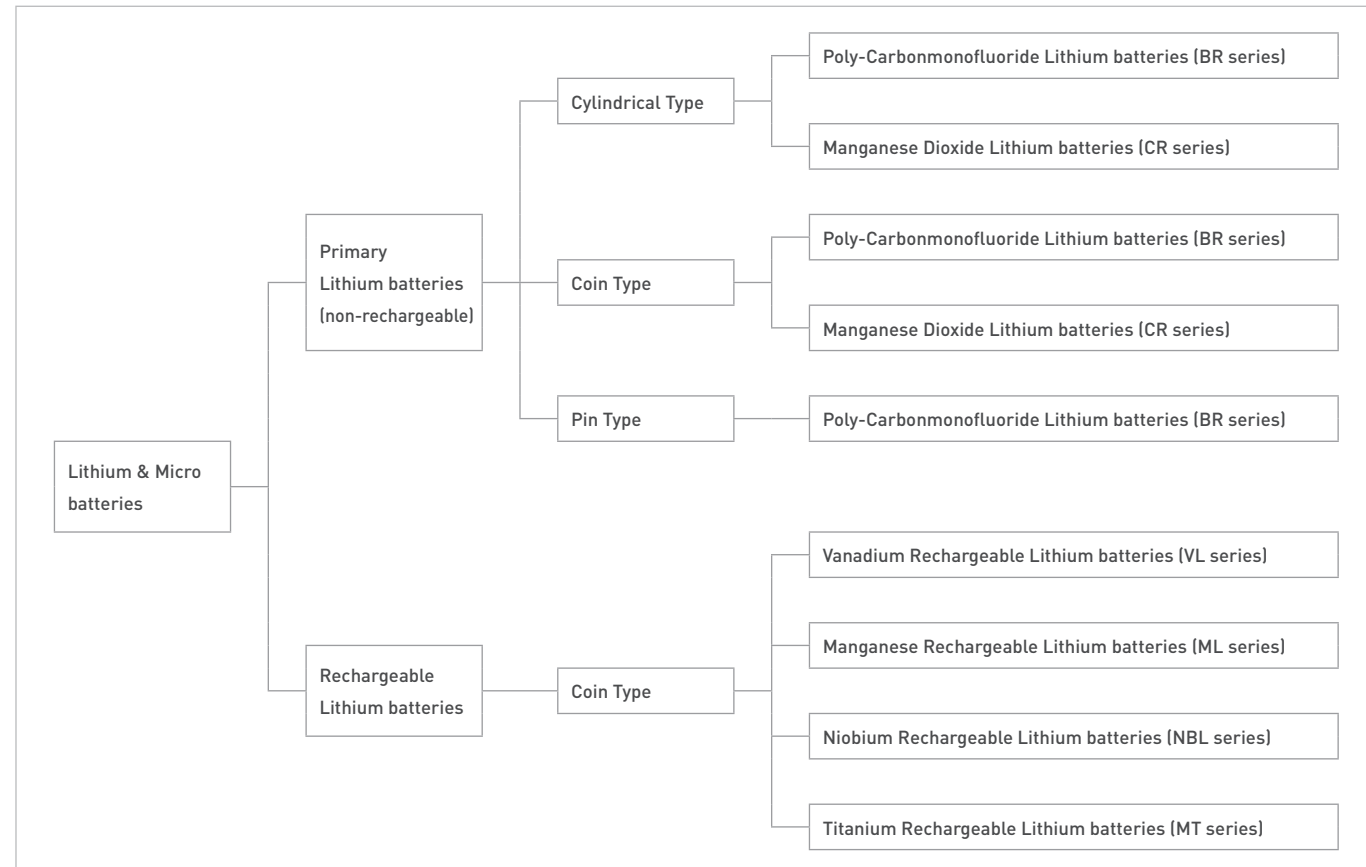

**High voltage**

The high energy density of Lithium batteries and their high voltage of 3V (there are 1.5V and 2V lineups also) make them ideally suited for use in all kinds of products where the trend is to achieve increasing miniaturization. A single Lithium battery can replace two, three or more conventional batteries. The figure on the right shows the number of cells required to provide the C-MOS IC data holding voltage for each type of battery.

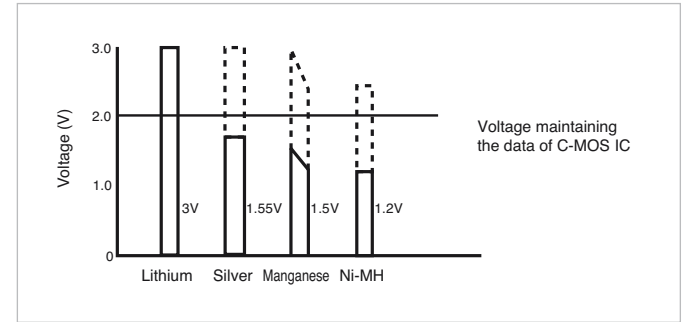

**Low selfdischarge rate and superior storability**

Since the substance that is chemically very stable is used for plus terminal as an active material (BR series: Poly-Carbonmonofluoride, CR series: Manganese Dioxide), if preservation conditions are proper, 90% of capacity remains even after ten years storage.

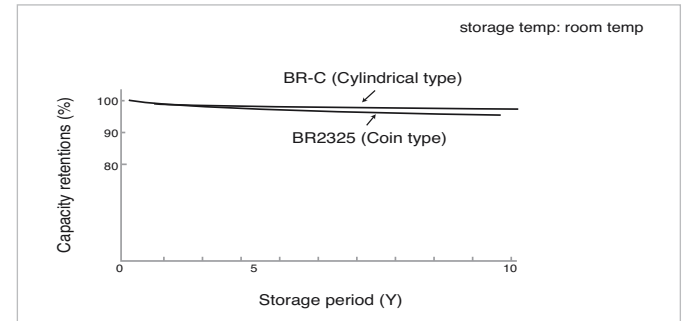

**Long-term discharge**

Long-term discharge has been verified at all operating temperatures under low-load discharge conditions.

**BR-2325**

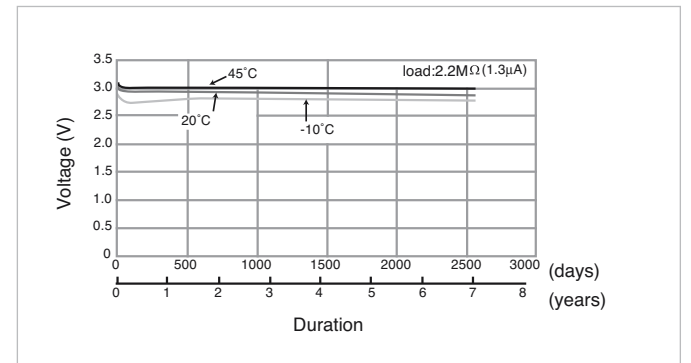

**BR-C**

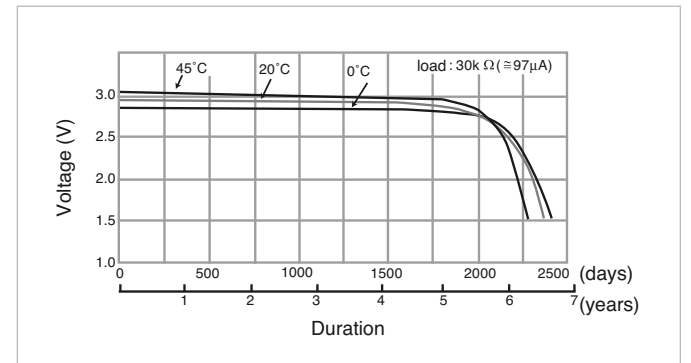

**Outstanding electrolyte leakage resistance**

Lithium batteries employ organic electrolytes with minimum creeping so they are vastly superior in terms of leakage resistance under environmental changes compared to other types of batteries that employ aqueous solution electrolytes. The batteries achieve stable characteristics under high temperature and humidity conditions (45°C/90% RH, 60°C/90% RH), and even under heat shock which constitutes the severest challenge for batteries.

| Leakage resistance evaluation items    | Test conditions              |
|--|------------------------------|
| High-temperature storage               | 60°C                         |
| High-temperature High-humidity storage | 45°C / 90%RH<br>60°C / 90%RH |
| Temperature cycle                      |                              |
| Heat shock                             |                              |

**Wide operating temperature range**

Due to the use of organic electrolytes with a solidifying point that is much lower than the aqueous solution electrolytes used in other types of batteries, Lithium batteries are capable of operation in a wide range of temperatures. Not only do the high operating temperature BR series cells use a special engineering plastic as the material for the gasket and separator instead of the conventional polyolefin resin but its operating temperature range has also been significantly increased by employing an electrolyte with a high boiling point.

**BR-2325** Operating voltage under high-resistance discharge

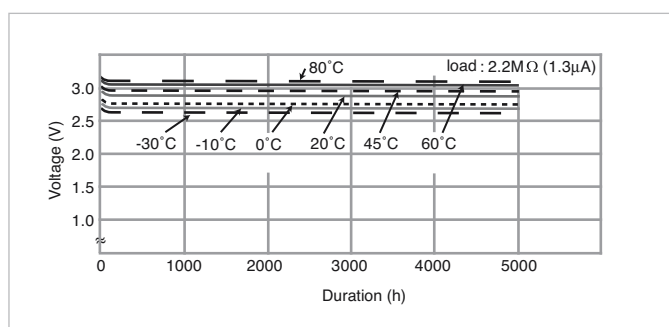

**BR-2/3A** Current drain vs. operation voltage

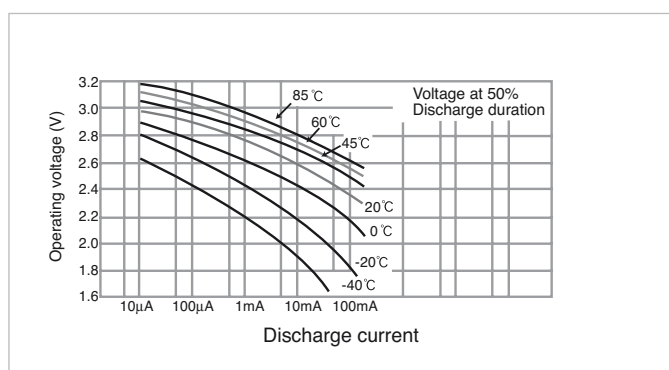

**Superior safety**

Lithium batteries feature stable substances for the active materials and a structural design that assures safety and, as such, their superior safety has been verified from the results of repeatedly subjecting them to a number of different safety tests. As a result, Panasonic's Lithium batteries have been approved under the safety standard (UL1642) of UL (Underwriters Laboratories Inc.).

**Battery surface temperature** when short-circuited

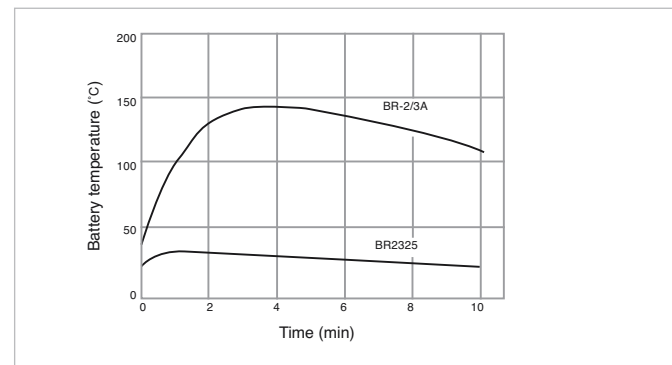

**BR-2325** Charge resistance (10V consistent-voltage charge)

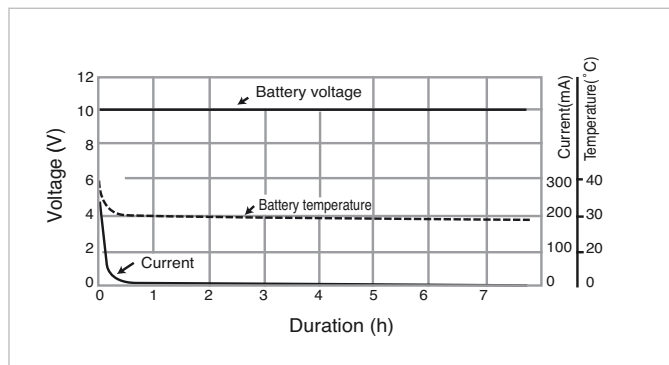

**Leakage resistance test results**

| Model   | Conditions | 60°C    |          | 45°C/90% |          | 60°C/90% |          | Temp. cycle | Heat shock |
|---------|------------|---------|----------|----------|----------|----------|----------|-------------|------------|
|         | Storage    | 1 month | 3 months | 1 month  | 3 months | 1 month  | 3 months | 60 cycles   | 120 cycles |
| BR-2325 |            | ○       | ○        | ○        | ○        | ○        | ○        | ○           | ○          |
| BR-2/3A |            | ○       | ○        | ○        | ○        | ○        | ○        | ○           | ○          |

**COIN TYPE RECHARGEABLE LITHIUM BATTERIES**

Rechargeable Lithium batteries come with excellent characteristics and high reliability.

- Long-term reliability
- High capacity
- Low self-discharge rate
- Resistance to continuous discharge
- Resistance to over discharge

**COMPARISON TABLE OF LITHIUM BATTERY TYPES**

| Item  | Type  | Primary battery |   | Rechargeable battery  |   |   |   |
|---|---|-----------------|---|---|---|---|---|
|   | Model   | BR              | CR  | VL  | ML  | NBL   | MT  |
| Material  | ⊕ electrode   | [CF]n           | MnO <sub>2</sub>                                    | V <sub>2</sub> O <sub>5</sub>   | LixMnOy   | Nb <sub>2</sub> O <sub>5</sub>  | LixOy   |
|   | ⊖ electrode   | Li              | Li  | LiAl  | LiAl  | LiAl  | LixTiOy   |
| Nominal voltage                                     |   | 3.0             | 3.0   | 3.0   | 3.0   | 2.0   | 1.5   |
| Operating temperature range (°C)                    | cylindrical :<br>-40 to +85<br>coin :<br>-30 to +80                     |                 | cylindrical :<br>-40 to +70<br>coin :<br>-30 to +60 |   |   |   |   |
|   | high operating temperature coin :<br>-40 to +125<br>pin :<br>-30 to +80 |                 |   | -20 to +60  | -20 to +60  | -20 to +60  | -10 to +60  |
| Self-discharge (per year) under standard conditions | Cylindrical type  | 0.5%            | 1.0%  | 2.0%  | 2.0%  | 2.0%  | 2.0%  |
|   | Coin type   | 1.0%            | 1.0%  |   |   |   |   |
| Average discharge voltage [V]                       |   | -               | -   | 2.85  | 2.5   | 1.5   | 1.2   |
| Charge voltage [V]                                  |   | -               | -   | 3.25 to 3.55  | 2.8 to 3.2  | 1.8 to 2.5  | 1.6 to 2.6  |
| Cut-off voltage [V]                                 |   | 2.0             | 2.0   | 2.5   | 2.0   | 1.0   | 1.0   |
| Charge-discharge cycles                             |   | -               | -   | 1,000 charge/discharge partly (charge/discharge for 10% of discharge depth) | 1,000 charge/discharge partly (charge/discharge for 10% of discharge depth) | 1,000 charge/discharge partly (charge/discharge for 10% of discharge depth) | 500 charge/discharge up to 1V or discharge limit voltage (charge/discharge for 100% of discharge depth) |

**COMPARISON BETWEEN BR AND CR**

| Model       | BR/CR                               |   |
|-------------|-------------------------------------|---|
| Performance | Discharge capacity                  | BR = CR   |
|             | Voltage during discharging          | BR < CR (Higher)  |
|             | Flatness of discharge voltage       | (Flatter) BR > CR   |
|             | Load characteristics                | BR < CR (Superior)  |
|             | Storage properties (self-discharge) | < 60°C (Less self-discharge) BR ≥ CR<br>> 60°C (Less self-discharge & stable) BR > CR |

**Notes:** In terms of their characteristics, the CR series provides a slightly higher voltage during discharge than the BR series. BR batteries, compared with CR batteries, show more stable characteristics with less discharge voltage variations. These characteristics should be taken into consideration when selecting a battery for each application.

- ◎ Recommended applications
- Potential applications

| PRIMARY TYPE                    |                                      | Coin type |             |           | Cylindrical type |           |                          | Pin type  |
|---------------------------------|--------------------------------------|-----------|-------------|-----------|------------------|-----------|--------------------------|-----------|
| Usage                           |                                      | BR series | BR-A series | CR series | BR series        | CR series | CR series for industrial | BR series |
| Cameras                         |                                      |           |             |           |                  | ◎         |                          |           |
| Household use                   | Lights                               |           |             |           | ○                | ○         |                          |           |
|                                 | Shaver                               |           |             |           |                  | ○         |                          |           |
| Watches                         | Analog                               | ○         |             | ○         |                  |           |                          |           |
|                                 | Digital                              | ○         |             | ○         |                  |           |                          |           |
|                                 | Clocks                               | ○         |             | ○         |                  |           |                          |           |
| Business use                    | Communication equipment              |           |             |           | ○                |           | ◎                        |           |
|                                 | Test equipment                       |           |             |           | ○                |           | ◎                        |           |
|                                 | Fire alarm                           |           |             |           | ○                |           | ◎                        |           |
| Meters (gas, water, etc)        |                                      |           |             |           | ◎                |           |                          |           |
| RTC/Memory back-up of SRAM card |                                      | ◎         | ◎           | ○         |                  |           |                          |           |
| Car equipment                   | Keyless entry                        |           |             | ○         |                  |           |                          |           |
|                                 | ETC                                  |           | ○           |           | ○                |           | ◎                        |           |
| Electronic organizer            |                                      |           |             | ○         |                  |           |                          |           |
| Portable game players           |                                      |           |             | ◎         |                  |           |                          |           |
| IC tags                         |                                      |           |             | ○         |                  |           |                          |           |
| IC cards                        |                                      |           |             | ○         |                  |           |                          |           |
| Fishing equipment               | Electronic float with lighting diode |           |             |           |                  |           |                          | ◎         |
|                                 | Light for a polediode                |           |             |           |                  |           |                          | ◎         |
|                                 | Lighted luresdiode                   |           |             |           |                  |           |                          | ◎         |
| Memory back-up (low load)       |                                      | ◎         | ◎           | ○         | ◎                |           |                          |           |

| RECHARGEABLE TYPE    |  | Coin type |           |            |           |
|----------------------|--|-----------|-----------|------------|-----------|
| Usage                |  | VL series | ML series | NBL series | MT series |
| Memory back-up       |  | ◎         | ◎         | ◎          | ○         |
| Keyless entry        |  | ○         |           |            |           |
| Rechargeable watches |  |           |           |            | ◎         |

### SELECTING A BATTERY

The steps for selecting the batteries for the power supplies of specific equipment are summarized below.

#### Preparation of required specifications (draft)

The required specifications (draft) are studied by checking the requirements for the batteries to be used as the power supplies of the specific equipment and their conditions against the battery selection standards. The technical requirements for battery selection are shown in the table below for reference purposes.

#### Selection of a battery

Select several candidate batteries by referring to the catalogs and data sheets of batteries which are currently manufactured and marketed. From this short list, select the battery which will best meet the ideal level of the requirements. In actual practice, however, the 'perfect' battery is seldom found by this method, instead, the basic procedure followed should be to examine the possibility of finding a compromise or partial compromise with the required specifications (draft) and then make a selection under the revised requirements from the batteries currently manufactured and marketed. Such a procedure enables batteries to be selected more economically. Questions and queries arising at this stage should be directed to our battery engineers. Sometimes, although it may not be

shown in the catalog, the appropriate battery has become available through recent development or improvement. As a rule, the required specifications are finalized at this stage.

#### Requests for developing or improving batteries

If the battery that meets the essential and specific requirements cannot be found through the selection process described above, a request for battery development or improvement should be made to our technical Department. A request like this should be coordinated as early as possible to allow for a sufficient study period. While this period depends on the nature of the request and the difficulties involved, a lead time of at least 6 to 12 months is usually required.

### MODEL NUMBER

#### How to interpret the model numbers generally used for coin type Lithium batteries

The model numbers are normally indicated using two upper-case English letters and a figure consisting of three or more digits as shown in the example below. This numbering system is supported by the Japan International Standard Committee of Clocks and Watches and is also an established practice in Japan.

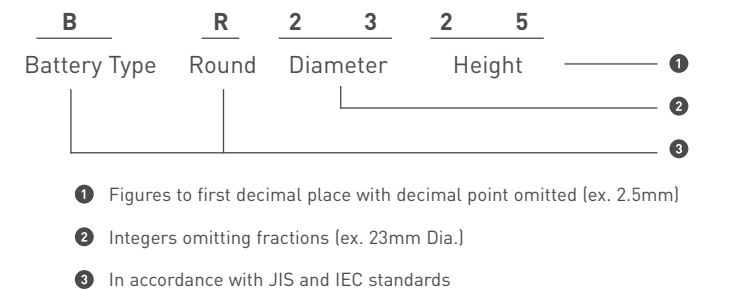

### TECHNICAL CONDITIONS FOR SELECTING BATTERIES

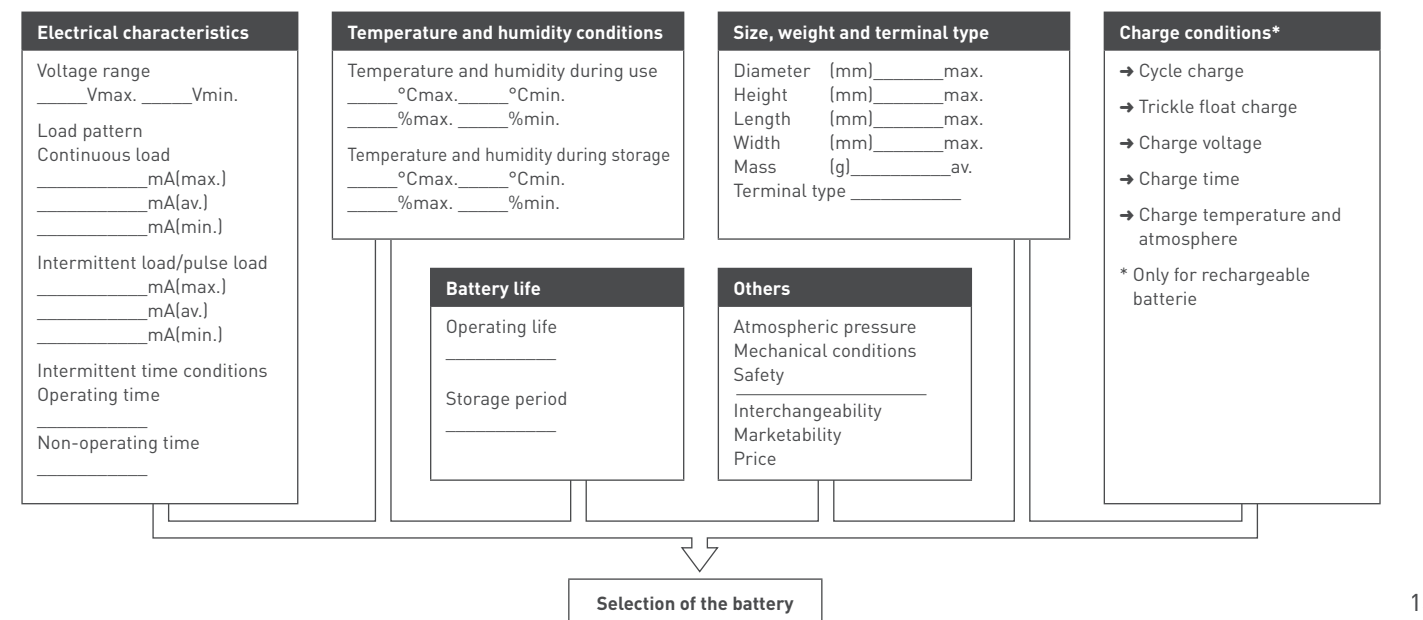

COIN TYPE PRIMARY LITHIUM BATTERIES (EXAMPLE)

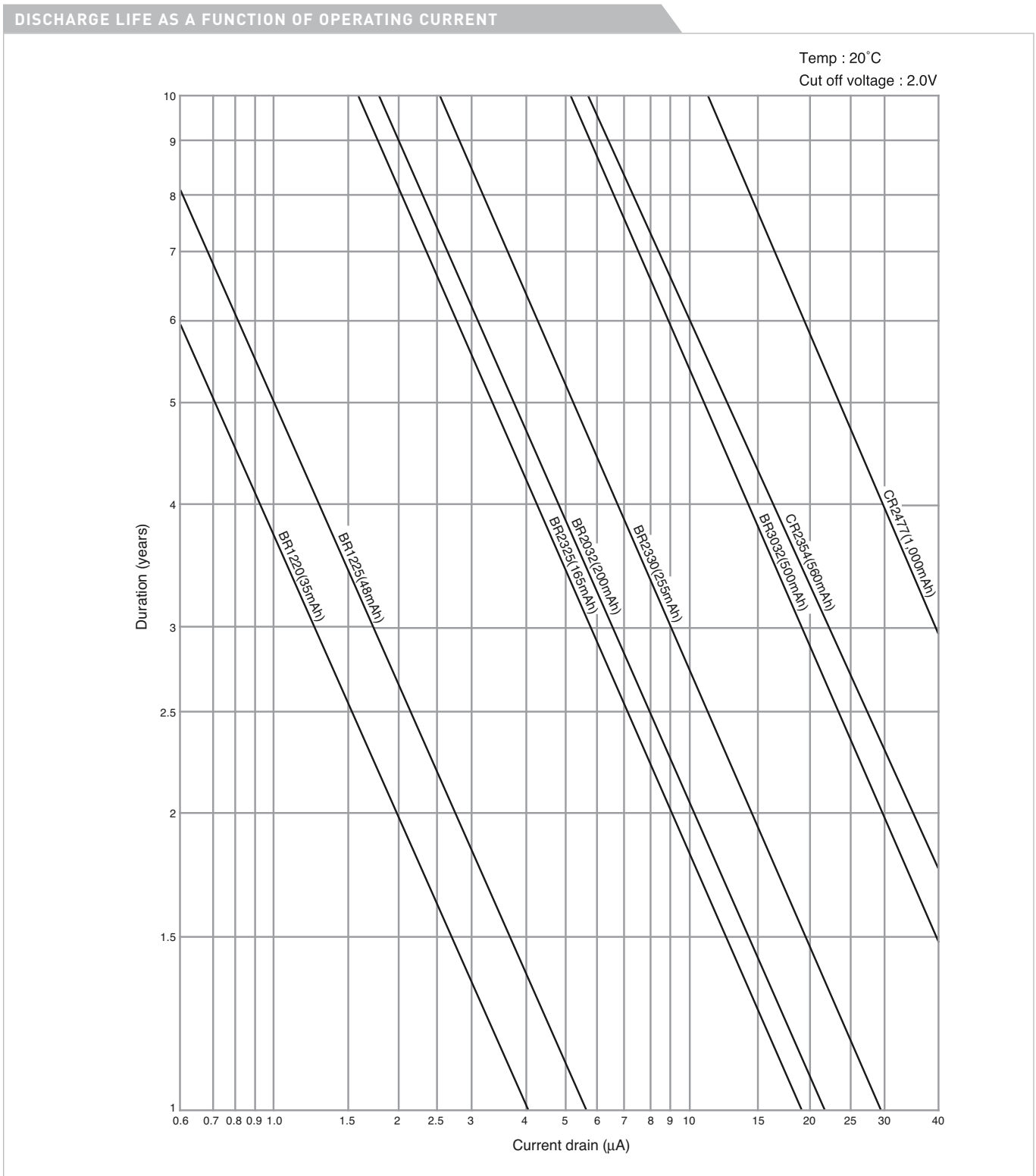

GENERAL FORMULA (ROUGH VALUE WITH 20°C, STANDARD LOAD)

**Calculation**      Duration (years) =  $\frac{\text{Nominal capacity (mAh)}}{\text{Current drain (mA)} \times 24 \text{ (hours)} \times 365 \text{ (days)}}$

CYLINDRICAL TYPE PRIMARY LITHIUM BATTERIES (EXAMPLE)

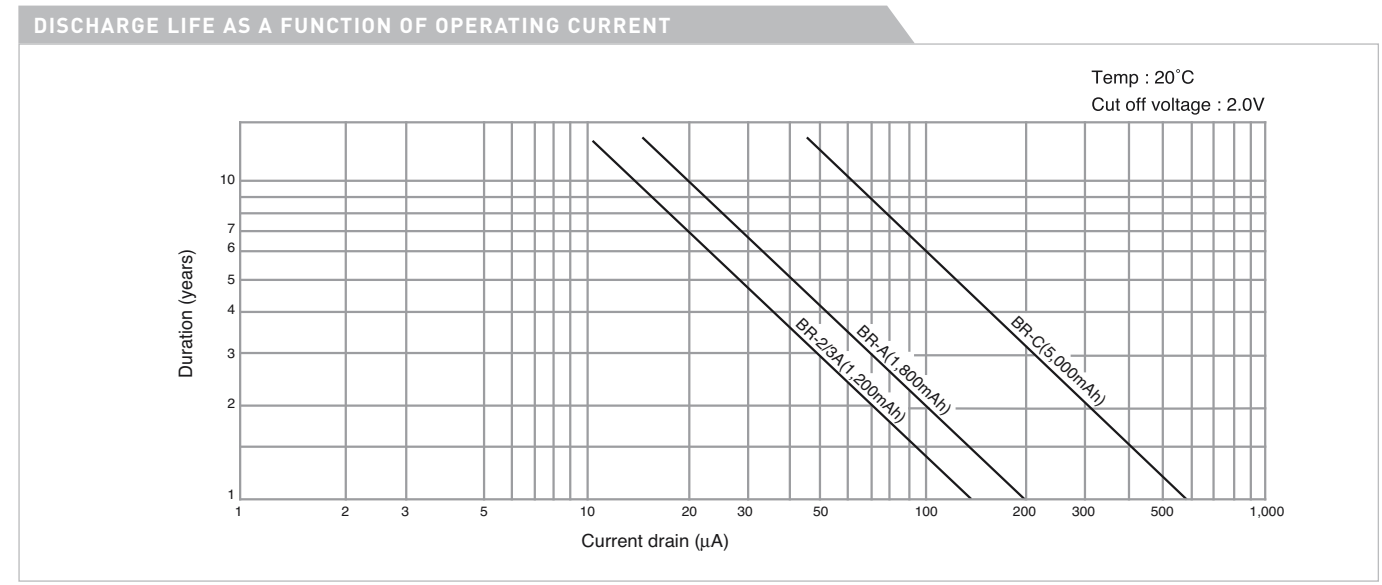

GENERAL FORMULA (ROUGH VALUE WITH 20°C, STANDARD LOAD)

**Calculation**      Duration (years) =  $\frac{\text{Nominal capacity (mAh)}}{\text{Current drain (mA)} \times 24 \text{ (hours)} \times 365 \text{ (days)}}$

## COIN TYPE RECHARGEABLE LITHIUM BATTERIES (EXAMPLE)

DISCHARGE LIFE AS A FUNCTION OF OPERATING CURRENT

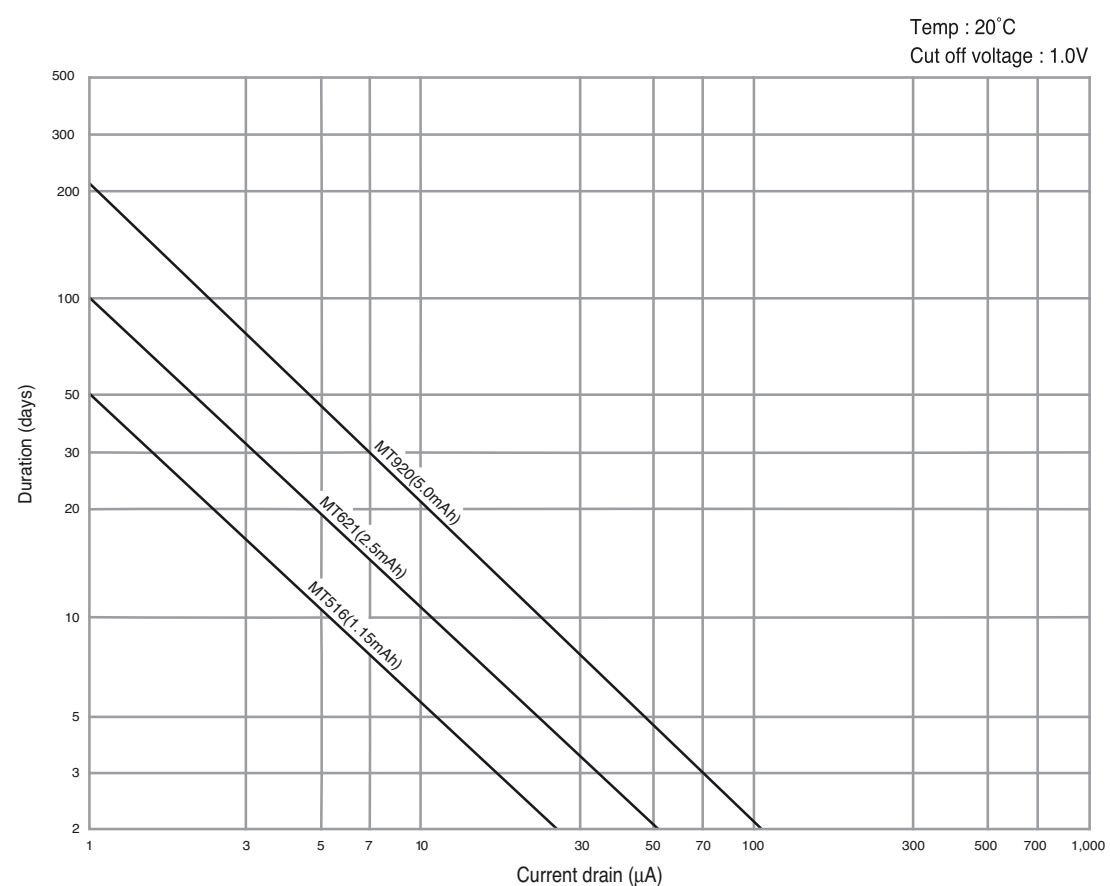
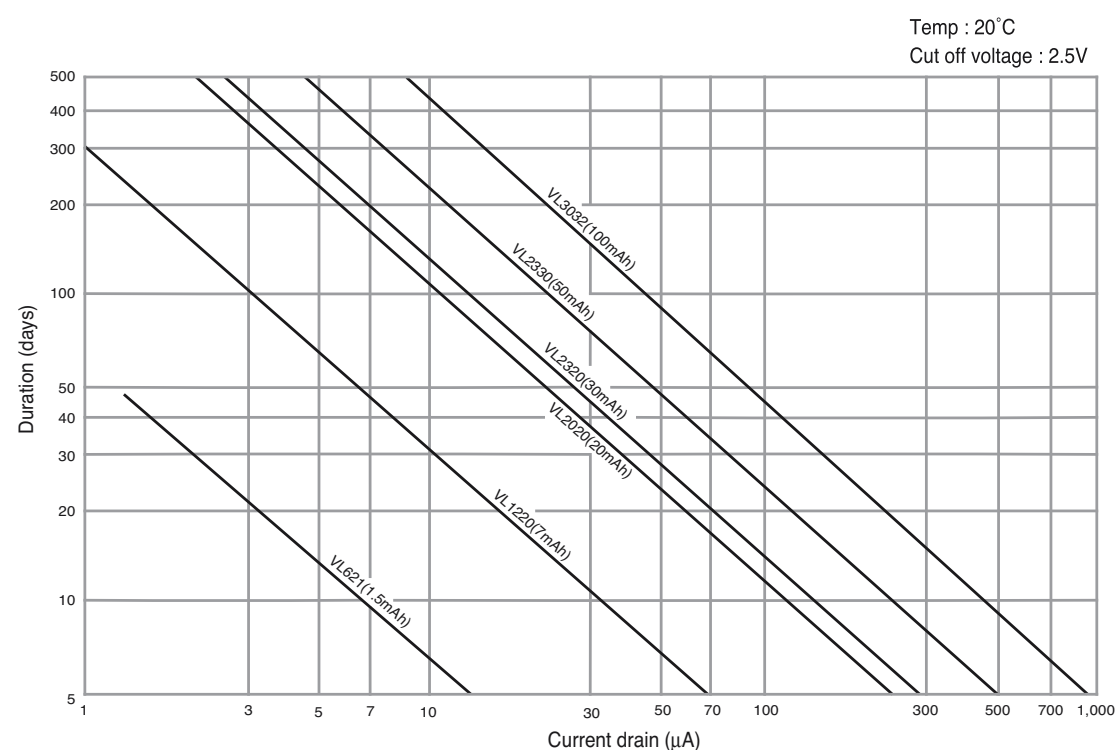

## APPLICABLE BOTH PRIMARY AND RECHARGEABLE BATTERIES

| Classification                    | Item   | Precaution  |
|-----------------------------------|--|---|
| Batteries                         | Voltage measurement  | To measure the battery voltage, use an instrument with an input resistance of 10MΩ or higher.   |
|                                   | Internal resistance measurement                              | To measure the internal resistance, use a 1000Hz AC instrument.   |
|                                   | Electrical characteristics check                             | Even minimal shorting causes the battery voltage to drop, requiring a period of time for the voltage to recover. Checking the voltage characteristics before the voltage has sufficiently recovered in such a situation may result in a misjudgment of battery voltage.   |
|                                   | Cleaning   | Prior to installation in the equipment, wipe the batteries and equipment terminals clean using a dry cloth, etc.  |
|                                   | Washing and drying   | → Washing: Use of a conductive detergent causes batteries to discharge, the battery voltage to drop and the battery performance to deteriorate in other ways. Be sure to use a non-conductive detergent.<br>→ Drying: The heat produced when the temperature of the battery units rises above 85 C deforms the gaskets and causes electrolyte leakage and a deterioration in performance. Be sure to dry batteries only for short periods of time at temperatures below 85 C.   |
|                                   | Mounting   | → Ensure that dust and other foreign substance will not cause shorting between the poles.<br>→ When handling batteries, wear finger covers or gloves made of rubber, cotton, etc. to protect the batteries from dirt.   |
|                                   | UL   | Strictly comply with the conditions outlined on the next page.  |
|                                   | Use of multiple batteries                                    | Give sufficient consideration to safety in design when a multiple number of batteries are to be used. Consult with Panasonic concerning packs of multiple batteries.  |
|                                   | Simultaneous use of other types of batteries                 | When other types of batteries are also to be used in the some equipment, design the circuitry in such a way that the current (leakage current) from the other batteries will not flow to the Lithium batteries. [This applies to primary batteries.]  |
|                                   | Use of batteries in series or in parallel                    | This requires special circuitry: Please consult with Panasonic. Do not use Lithium batteries together with different types of batteries in series or in parallel.   |
| Battery compartments in equipment | Battery life   | Prior to installation in the equipment, wipe the batteries and equipment terminals clean using a dry cloth, etc.  |
|                                   | Design   | → Ensure that the batteries can be replaced easily and that they will not fall out of position.<br>→ Give consideration to the battery dimensions, tolerances, etc.<br>→ Give consideration to the shape of ⊕ and ⊖ electrodes of the batteries and their tolerances to prevent installation in reverse.<br>→ Clearly indicate on the battery compartment the type of batteries to be used and their correct installation direction (polarities).<br>→ Limit the electrical circuits inside the battery compartment only to the circuits relating to the battery contacts.<br>→ With the exception of the terminal areas, insulate the battery compartment from the electrical circuits.<br>→ Take steps to minimize any damage to the equipment resulting from electrolyte leakage from the battery compartment.<br>→ Batteries should be free from leakage of liquids, which can damage equipment and spoil the contact at terminals, making the operation of equipment unstable. |
|                                   | Battery layout and construction and materials of compartment | → Take steps to ensure the batteries are not located heat generating component in the equipment. Installing batteries near a heat source will heat up the batteries, causing thermal deformation of the gasket and resulting in electrolyte leakage and a deterioration in characteristics.<br>→ Adopt a construction which allows the gases to be vented.<br>→ Give consideration to the impact and the effect on the environment in selecting the materials to be used.   |
| Contacts and connection terminals | Contact point materials                                      | Use nickel-plated iron or nickel-plated stainless steel for the contact points.   |
|                                   | Contact pressure of contacts                                 | In order to ensure stable contact, use the following levels of contact as a general guideline:<br>5N to 15N for cylindrical types<br>2N to 10N for coin types.  |
|                                   | Shape of terminals   | Use of Y-shaped terminals (2-point contact) for both the ⊕ and ⊖ electrodes yield stable contact.   |
|                                   | Connection terminals   | If lead wires and connection terminals such as tab terminals are required for the batteries, consult with Panasonic since we offer a range of external terminals (connectors, etc.).  |

| Classification | Item | Precaution   |
|----------------|------|--|
| Notes          |      | <p>1. Shorting causes the battery voltage to drop to about 0V before slowly recovering from the open state. It takes time for the initial voltage to be restored. Notice that measuring the open-circuit voltage immediately after shorting may lead to a misjudgment that the battery is abnormal. The figure on the right illustrates how voltage recovers after shorting.</p> <p>2. Reverse current preventing diodes. Since Lithium primary batteries are not rechargeable, use of a reverse current preventing diode and a protective resistor in series is required where there is the possibility of charging in the equipment circuit. Use a silicon diode or Schottky diode with a low reverse current as the reverse current preventing diode. To maintain the characteristics of a coin-type Lithium battery, the total charging amount of the battery during its total usage period must be kept within 3% of the nominal capacity of the battery.</p> |
|                |      | <p><b>BR-2/3A</b> voltage recovery after short-circuited (example)</p> <p>(A) 2-cell 6V usage      (B) Parallel usage      (C) UL conditions</p>   |

**PRIMARY BATTERIES**

Since Lithium primary batteries are not rechargeable, use a reverse current blocking diode and a protective resistor in series where there is the possibility of charging in the equipment circuit.

**Reverse current blocking diode**

**Diode used**

Use a low leak current diode (this current varies with temperature).

**Selection standard**

The total allowable charging amount of a battery during its total usage period must not be greater than 3% of the nominal capacity of the battery for a coin type battery or 1% for a cylindrical battery.

**Example**

When a CR-2477 (1000mAh) coin-type battery is to be used for 5 years, a reverse current preventing diode with a reverse current of 0.7μA or less is required.

**Calculation method**

1000mAh (CR-2477) x ≤ 3% (coin type battery) = ≤ 30mAh

30mAh ÷ usage period (5years x 365 days x 24 hours) = 0.7μA

**Use of protective resistor in series: Selection and installation (UL Standard)**

A resistor must be installed in series with the battery to limit the charge current which will flow to the battery in case of destruction in continuity of the reverse current preventing diode. The maximum allowable current is specified for each battery size in the table at the right, and the resistance value of the protective resistor is determined as:

$R > V \div I$  (where 'I' is the maximum allowable charge current specified by UL).

**Conditions for UL Standard**

(Contact Panasonic for further details.)

**1. Use of protective resistor in series**

**Selection**

Select the protective resistor in such a way that the charge current which will flow to the battery when the diode is destroyed is less than the value given in the table on the right.

**Installation**

To protect the battery from being charged in the event of the destruction of the diode, install a protective resistor in series with the battery.

**2. Battery replacement**

**Replacement by qualified engineer**

These batteries are intended for use as a part of an electrical circuit in equipment and any battery with an asterisk '\*' in the table on the right should only be replaced by a qualified engineer.

**Replacement by user**

Those Lithium batteries which are not accompanied by an asterisk '\*' in the table on the right and which include the use of up to four of them in series or in parallel may be replaced by users provided that the conditions specified by the UL Standard are met.

**Use in series or in parallel**

In replacing up to four batteries, the batteries must all be replaced with new ones at the same time. Set the maximum allowable charge current to within the current permitted by the number of batteries in series or in parallel.

**RECHARGEABLE BATTERIES**

**Use of multiple batteries**

Consult with Panasonic if two or more Vanadium rechargeable Lithium batteries (VL series) or Manganese rechargeable Lithium batteries (ML series) are to be used in series or in parallel.

**Charging**

Details on the charge voltage, charge current and charge circuit are given for each type of battery.

**Conditions of UL approval**

The maximum charge current must be restricted to 300mA when protective components have been subjected to short- or open-circuiting.

PRIMARY AND RECHARGEABLE BATTERIES

○ UL approval

| UL APPROVAL AND MAXIMUM ALLOWABLE CHARGE CURRENT |   |             |  |     |
|--|---|-------------|--|-----|
| Shape  | Model number                              | UL approval | Maximum abnormal charging current (mA) |     |
| Primary Lithium batteries                        | Cylindrical Type BR series                | BR-1/2AA    | ○                                      | 5   |
|  |   | BR-2/3A     | ○                                      | 10  |
|  |   | BR-2/3AG    | ○                                      | 10  |
|  |   | BR-A*       | ○                                      | 15  |
|  |   | BR-AG*      | ○                                      | 15  |
|  |   | BR-C*       | ○                                      | 20  |
|  | Cylindrical Type CR series                | CR-2        | ○                                      | 20  |
|  |   | CR-123A     | ○                                      | 25  |
|  |   | 2CR-5       | ○                                      | 25  |
|  |   | CR-P2       | ○                                      | 25  |
|  |   | CR-V3       | ○                                      | 25  |
|  |   | CR-AAZ*1    | ○                                      | xx  |
|  | Cylindrical Type CR series for industrial | CR-2/3AZ    | ○                                      | 25  |
|  |   | CR-AG*      | ○                                      | 25  |
|  | Coin Type BR series                       | BR-1220     | ○                                      | 3   |
|  |   | BR-1225     | ○                                      | 3   |
|  |   | BR-1632     | ○                                      | 4   |
|  |   | BR-2032     | ○                                      | 5   |
|  |   | BR-2325     | ○                                      | 5   |
|  |   | BR-2330     | ○                                      | 5   |
|  | Coin Type BR-A series                     | BR-3032     | ○                                      | 5   |
|  |   | BR-1225A    | ○                                      | 3   |
|  |   | BR-1632A    | ○                                      | 4   |
|  |   | BR-2330A*   | ○                                      | 5   |
|  |   | BR-2450A*   | ○                                      | 5   |
| BR-2477A*  |   | ○           | 5                                      |     |
| Coin Type CR series                              | CR-1025                                   | ○           | 2                                      |     |
|  | CR-1216                                   | ○           | 3                                      |     |
|  | CR-1220                                   | ○           | 3                                      |     |
|  | CR-1612                                   | ○           | 3                                      |     |
|  | CR-1616                                   | ○           | 4                                      |     |
|  | CR-1620                                   | ○           | 4                                      |     |
|  | CR-1632                                   | ○           | 4                                      |     |
|  | CR-2012                                   | ○           | 10                                     |     |
|  | CR-2016                                   | ○           | 10                                     |     |
|  | CR-2025                                   | ○           | 10                                     |     |
|  | CR-2032                                   | ○           | 10                                     |     |
|  | CR-2330                                   | ○           | 10                                     |     |
|  | CR-2354                                   | ○           | 10                                     |     |
|  | CR-2412                                   | ○           | 10                                     |     |
|  | CR-2450                                   | ○           | 30                                     |     |
|  | CR-2477                                   | ○           | 10                                     |     |
|  | CR-3032                                   | ○           | 10                                     |     |
|  | Pin Type BR series                        | BR-425      | ○                                      | 0.1 |
| BR-435   |   | ○           | 0.2                                    |     |
| Rechargeable Lithium batteries                   | Coin Type VL series                       | VL-621*     | ○                                      | 300 |
|  |   | VL-1220     | ○                                      | 300 |
|  |   | VL-2020     | ○                                      | 300 |
|  |   | VL-2320     | ○                                      | 300 |
|  |   | VL-2330     | ○                                      | 300 |
|  |   | VL-3032     | ○                                      | 300 |
|  | Coin Type ML series                       | ML-414      | ○                                      | 300 |
|  |   | ML-421      | ○                                      | 300 |
|  |   | ML-614      | ○                                      | 300 |
|  |   | ML-621      | ○                                      | 300 |
| Coin Type NBL series                             | ML-920                                    | ○           | 300                                    |     |
|  | ML-1220                                   | ○           | 300                                    |     |
|  | ML-2020*                                  | ○           | 300                                    |     |
|  | NBL-414                                   | ○           | 300                                    |     |
| Coin Type MT series                              | NBL-621                                   | ○           | 300                                    |     |
|  | MT-516                                    | ○           | 300                                    |     |
|  | MT-621                                    | ○           | 300                                    |     |
| Reflowable Coin Type ML-R/NBL-R series           | MT-920                                    | ○           | 300                                    |     |
|  | ML-414RM                                  | ○           | 300                                    |     |
|  | NBL-414L                                  | ○           | 300                                    |     |

\* Please read 'Conditions for compliance with UL Standard' carefully.  
\*1 Development concluded but large-scale production not started yet.

Selecting batteries

When selecting batteries, give consideration to such factors as the current consumption of the equipment in which the batteries are to be used, the expected life of the batteries, and temperature in the operating environment. At low operating environment temperatures, the consumption current of the ICs drops but the discharge voltage of the batteries will also decrease. Also it is important to note that the capacity deterioration of batteries in long-term use becomes significant at high operating environment temperatures.

Memory back-up circuit and holding voltage

The circuit typically used for memory back-up is shown in the figure on the right. The memory holding voltage is expressed as:  $V_B - V_F - I_F \times R >$  memory holding voltage of IC.

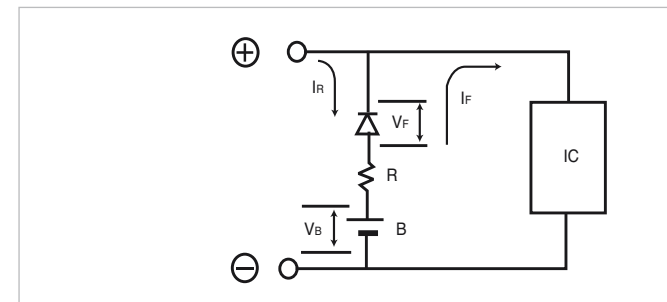

Reverse current blocking diode

Since Lithium primary batteries are not rechargeable, use of a reverse current blocking diode and a protective resistor in series is required where there is the possibility of charging in the equipment circuit. Use a diode with a low leak current as the reverse current blocking diode. To maintain the characteristics of a coin type Lithium battery, the total charging amount of the battery during its total usage period must be kept within 3% of the nominal capacity of the battery.

For example, assuming that a CR-2477 (1000mAh) will be used in a memory back-up power supply for 5 years, charging by the leak current of the reverse current blocking diode should be no greater than 30mAh (= 3% of 1000mAh), thus:  $30\text{mAh} \div \text{usage period (5 years} \times 365 \text{ days} \times 24 \text{ hours)} = 0.7\mu\text{A}$ . In other words, a leak current blocking diode whose reverse current is not greater than  $0.7\mu\text{A}$  must be selected.

Allowable total charging amount

- Within 3% for coin type batteries
- Within 1% for cylindrical type batteries

Note that the leakcurrent of reverse current blocking diodes varies with temperature.

(A) 2-cell 6V usage

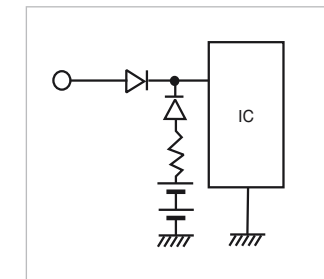

(B) Parallel usage

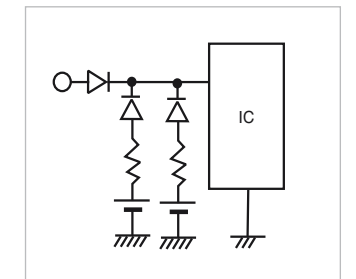

(C) UL conditions

(When a protective resistor has been inserted)

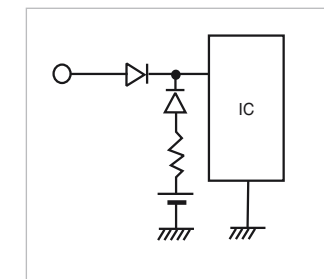

(D) UL conditions

(Protective Diode)

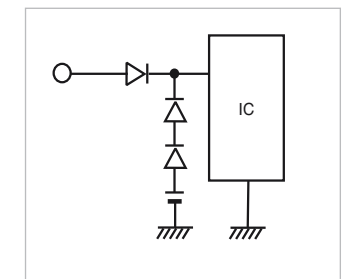

# 1 DESIGN FOR MEMORY BACK-UP USE

## Charge test results assuming diode leakage current

BR-2/3A (cylindrical type) charge test

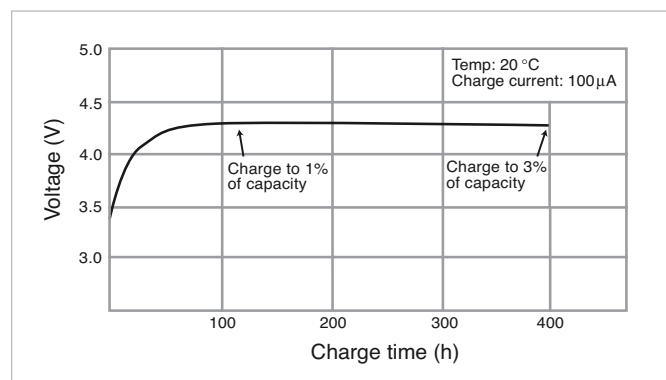

BR-2/3A (cylindrical type) discharge test after charging

